

Partdrawing for GA029GM201 - Haakse slijper

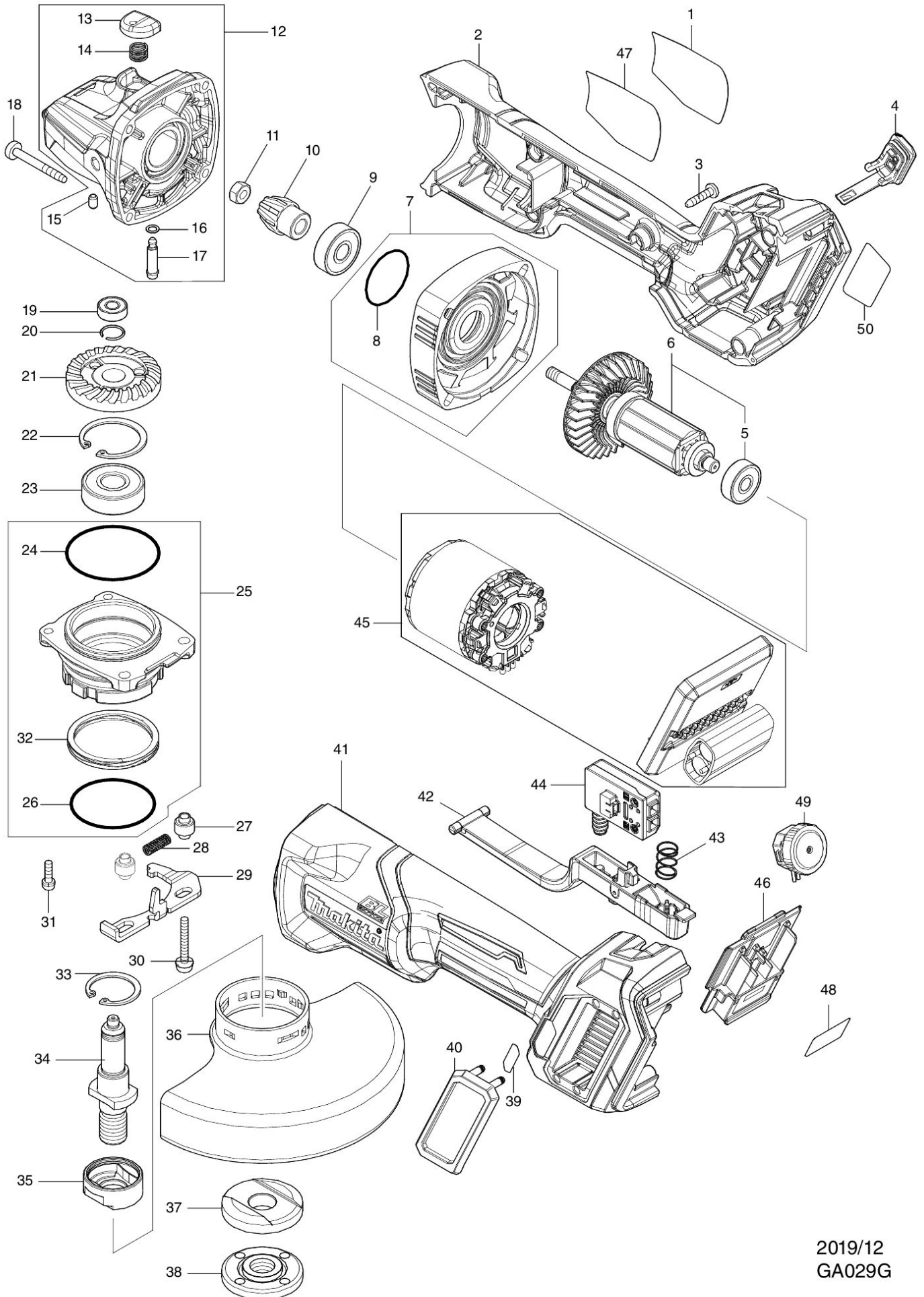

2019/12
GA029G