

Partdrawing for GA016GM201 - Haakse slijper

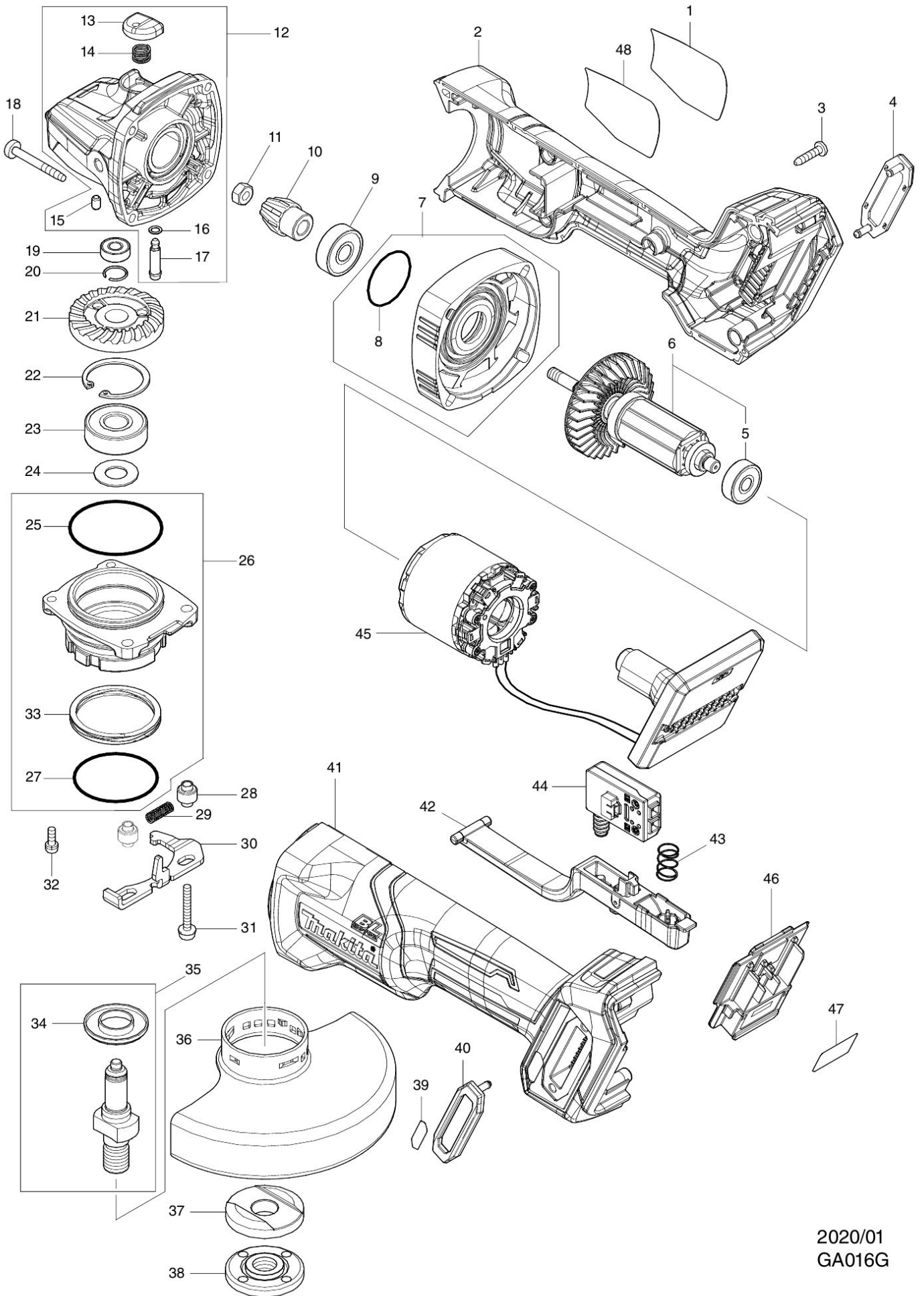

2020/01
GA016G