

Partdrawing for GA008GM201 - Haakse slijper

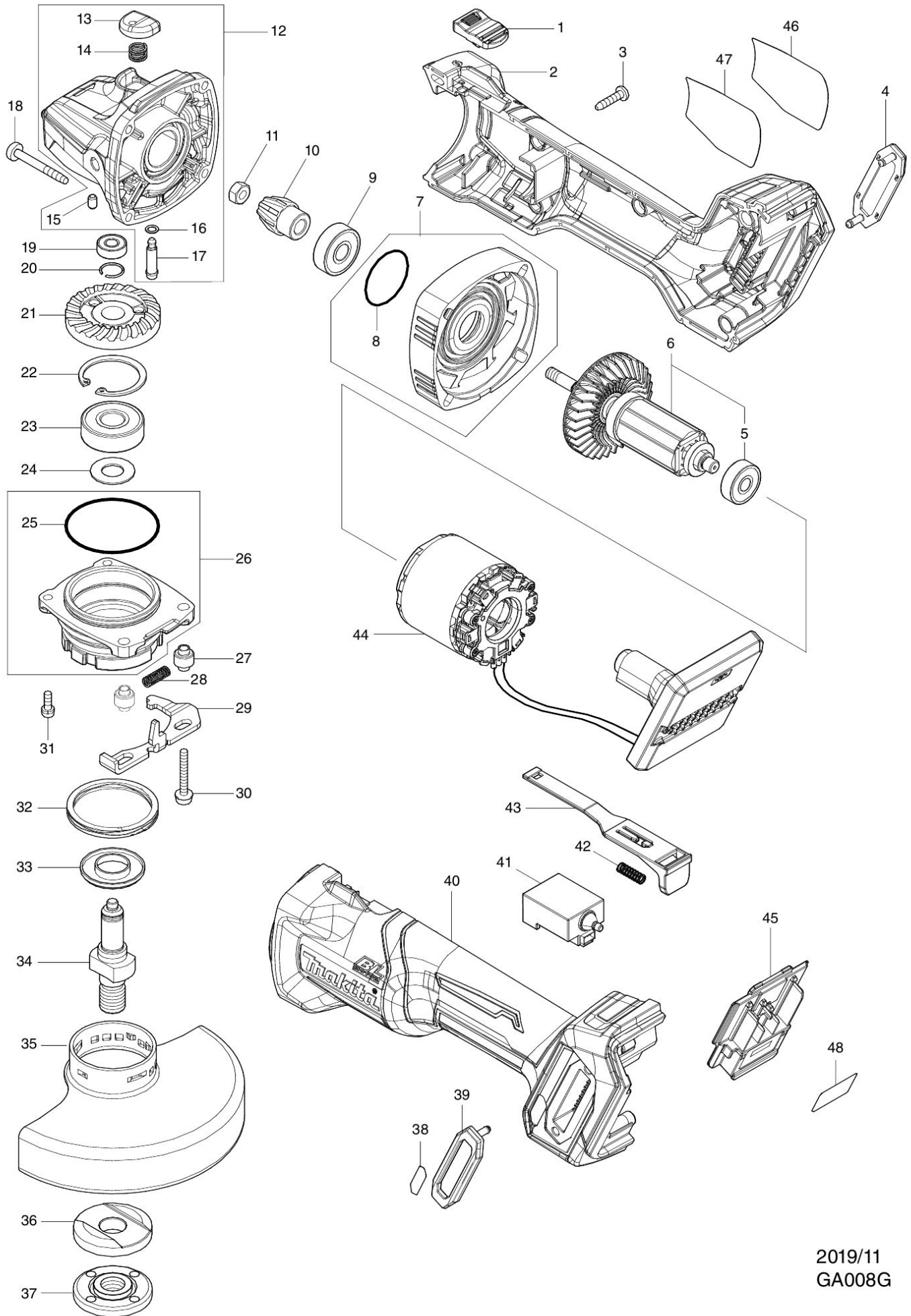

2019/11
GA008G