

Partdrawing for DTDA140Z - Slagschroevendraaier

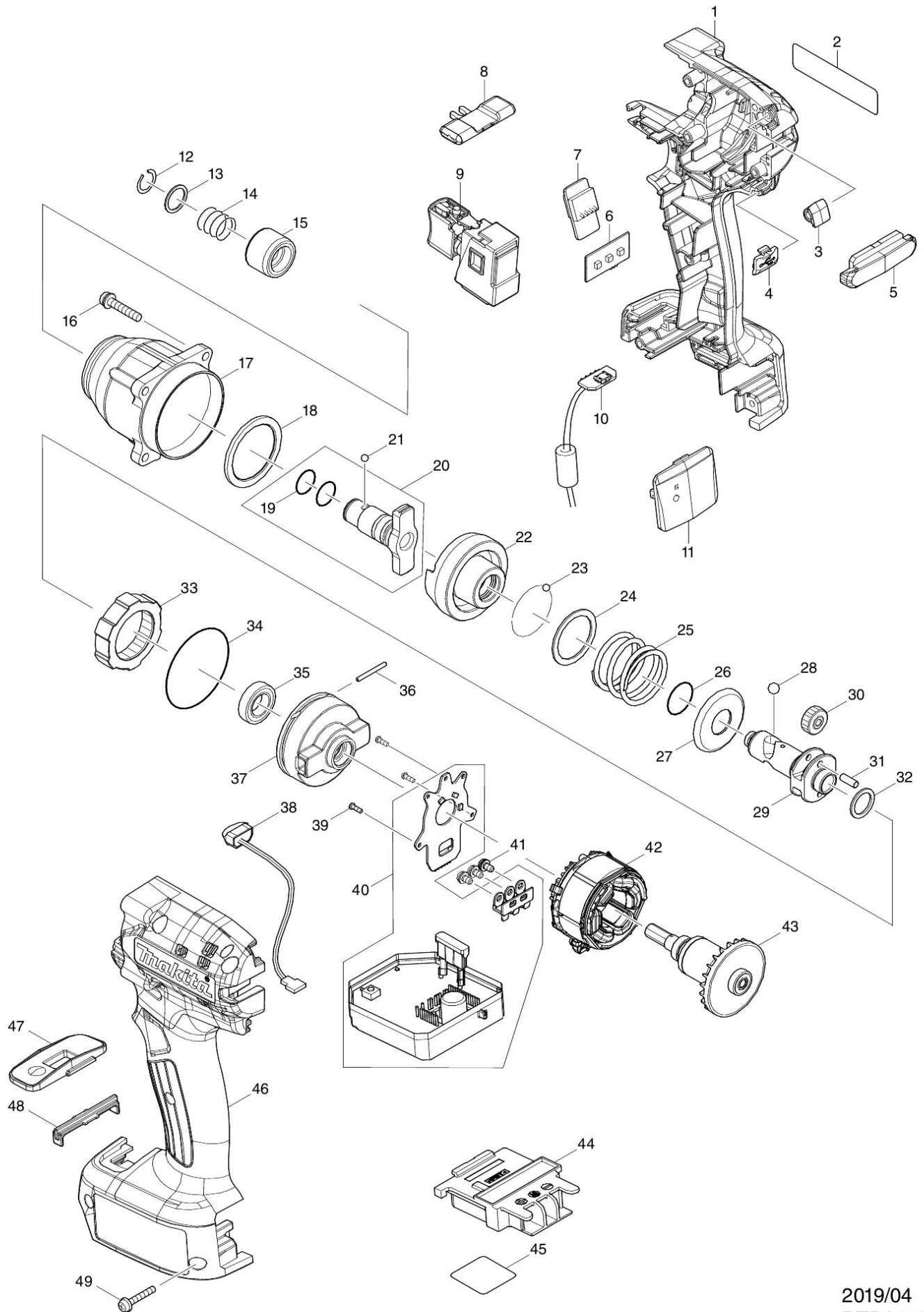

2019/04
DTDA140